



TrackingTheWorld
GPS Tracking Solutions



TrackingTheWorld.com

PT-301

**Personal Tracking Device
and Safety Phone**

USER MANUAL



Document Title	PT-301 User manual
Version	1.00
Date	2016-6-21
Status	Release
Document Control ID	TTW-PT301-UM001

General Notes

TrackingTheWorld offers this information as a service to its customers, to support application and engineering efforts that use the products designed by TrackingTheWorld. The information provided is based upon requirements specifically provided to TrackingTheWorld by the customers. TrackingTheWorld has not undertaken any independent search for additional relevant information, including any information that may be in the customer's possession. Furthermore, system validation of this product designed by TrackingTheWorld within a larger electronic system remains the responsibility of the customer or the customer's system integrator. All specifications supplied herein are subject to change.

Copyright

This document contains proprietary technical information which is the property of TrackingTheWorld, copying of this document and giving it to others and the using or communication of the contents thereof, are forbidden without express authority. Offenders are liable to the payment of damages. All rights reserved in the event of grant of a patent or the registration of a utility model or design. All specification supplied herein are subject to change without notice at any time.

Copyright © TrackingTheWorld 2016

For More Information: Please contact TrackingTheWorld, 1633 Bayshore Highway, Suite 390, Burlingame, CA. 94010, USA
Phone: +1.650.692.8100 – Email: info@trackingtheworld.com – Website: www.trackingtheworld.com

Copyright © TrackingTheWorld. All rights reserved. Information in this publication supersedes that in all previously published material. Specification and price change privileges reserved. All trade names referenced are the service marks, trademarks, or registered trademarks of their respective companies.

Contents

Contents	3
0. Revision history	4
1. Introduction	5
2. Product Overview	6
2.1. Appearance	6
2.2. Keypad and Mini USB Interface Description	7
2.3. Icon Description	8
3. Getting Started.....	9
3.1. Parts List.....	9
3.2. Battery Charging	9
3.3. Install the SIM Card.....	10
3.4. Turning PT-301 On or Off.....	10
3.5. Make a Normal Call.....	10
3.6. Make an Emergency Call.....	11
4. Function Menu	12
4.1. Menu Tree.....	12
4.2. Call History	13
4.3. Check GPS	13
4.4. Check GPS	13
4.5. Sound	13
4.6. Settings.....	14
4.7. Alarm.....	14
4.8. Alarm.....	14
5. Troubleshooting and Safety Info.....	15
5.1. Troubleshooting.....	15
5.2. Safety Info	16

For More Information: Please contact TrackingTheWorld, 1633 Bayshore Highway, Suite 390, Burlingame, CA. 94010, USA
Phone: +1.650.692.8100 – Email: info@trackingtheworld.com – Website: www.trackingtheworld.com

Copyright © TrackingTheWorld. All rights reserved. Information in this publication supersedes that in all previously published material. Specification and price change privileges reserved. All trade names referenced are the service marks, trademarks, or registered trademarks of their respective companies.

0. Revision history

Revision	Date	Author	Description of change
1.00	2016-06-21	Richard Deng	Initial

For More Information: Please contact TrackingTheWorld, 1633 Bayshore Highway, Suite 390, Burlingame, CA. 94010, USA
Phone: +1.650.692.8100 – Email: info@trackingtheworld.com – Website: www.trackingtheworld.com

Copyright © TrackingTheWorld. All rights reserved. Information in this publication supersedes that in all previously published material. Specification and price change privileges reserved. All trade names referenced are the service marks, trademarks, or registered trademarks of their respective companies.

1. Introduction

PT-301 is a powerful A-GPS locator with mini size, light weight, superior receiving sensitivity and fast TTFF which works on GSM frequencies 850/900/1800/1900 MHz. PT-301 is designed for many applications such as human body or vehicle security, specific target to be tracked, emergency call, and management for specific purpose and target. PT-301 has 4 preset numbers and an SOS number. Users can set the 4 number keys and SOS key through software. By using PT-301, users can not only realize SOS alarm, real-time location query and voice call functions but also get the device's history track by visiting website.

For More Information: Please contact TrackingTheWorld, 1633 Bayshore Highway, Suite 390, Burlingame, CA. 94010, USA
Phone: +1.650.692.8100 – Email: info@trackingtheworld.com – Website: www.trackingtheworld.com

Copyright © TrackingTheWorld. All rights reserved. Information in this publication supersedes that in all previously published material. Specification and price change privileges reserved. All trade names referenced are the service marks, trademarks, or registered trademarks of their respective companies.

2. Product Overview

2.1. Appearance

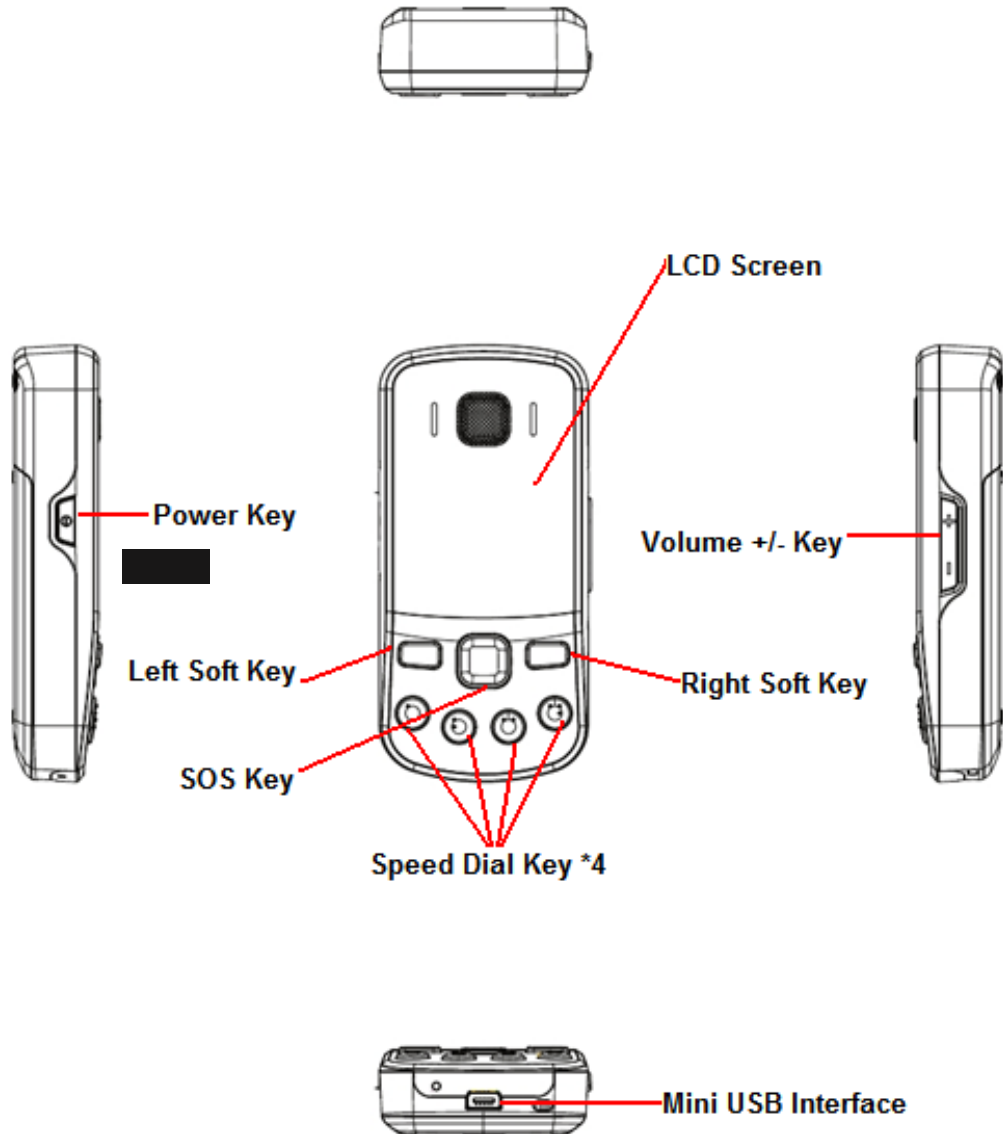

For More Information: Please contact TrackingTheWorld, 1633 Bayshore Highway, Suite 390, Burlingame, CA. 94010, USA
Phone: +1.650.692.8100 – Email: info@trackingtheworld.com – Website: www.trackingtheworld.com

Copyright © TrackingTheWorld. All rights reserved. Information in this publication supersedes that in all previously published material. Specification and price change privileges reserved. All trade names referenced are the service marks, trademarks, or registered trademarks of their respective companies.

2.2. Keypad and Mini USB Interface Description

Keypad Function Description	
Power Key	<ul style="list-style-type: none"> ● Hold down this key to turn on / turn off PT-301. ● In standby mode, press this key to lock/unlock the keypad.
Volume +/- Key	<ul style="list-style-type: none"> ● In standby mode, press this key to increase or decrease the keypad volume; ● While talking, press this key to increase or decrease the voice volume. ● In menu, press this key to page up or down. ● Press this key to set alarm time.
Left Soft Key	<ul style="list-style-type: none"> ● In standby mode, press this key to enter the main menu. ● Press this key to perform the function of the prompt displayed in lower left corner of the screen. ● Select a contact and then press this key to dial call. ● When there is an incoming call, press this key to answer the call.
Right Soft Key	<ul style="list-style-type: none"> ● Press this key to perform the function of the prompt displayed in lower right corner of the screen. ● While talking, press this key to end a call. ● When there is an incoming call, press this key to reject the call. ● In standby mode, hold down this key to switch between General and Silent mode.
Speed Dial (1, 2, 3, 4) Key	<ul style="list-style-type: none"> ● In standby mode, press this key to show the preset contact. ● Press Speed Dial Key 1, 2, 3 and 4 in menu to speed dial.
SOS Key	<ul style="list-style-type: none"> ● Hold down this key to dial the SOS number under any interface.











MINI USB Interface Description	
Mini USB Interface	<ul style="list-style-type: none"> ● Plug the AC power adapter to this interface for charging battery. ● Before you use the USB earphone, insert it to this interface.

Note: In this manual, the phrase “press the key” refers to pressing and thereafter releasing a key; “Hold down a key” refers to pressing a key and keeping it depressed for 2 seconds or longer.

For More Information: Please contact TrackingTheWorld, 1633 Bayshore Highway, Suite 390, Burlingame, CA. 94010, USA
Phone: +1.650.692.8100 – Email: info@trackingtheworld.com – Website: www.trackingtheworld.com

Copyright © TrackingTheWorld. All rights reserved. Information in this publication supersedes that in all previously published material. Specification and price change privileges reserved. All trade names referenced are the service marks, trademarks, or registered trademarks of their respective companies.

2.3. Icon Description

Icon	Description	Display Place
	Signal intensity of internet	icon area
	GPRS connect(ed)	icon area
	Keyboard locked	icon area
	Silent mode activated	icon area
	Earphone mode activated	icon area
	Ring mode	icon area
	Vibration mode	icon area
	Receive short message	icon area
	Start up alarm	icon area
	Display batteries level	icon area
	Missed calls	icon area

For More Information: Please contact TrackingTheWorld, 1633 Bayshore Highway, Suite 390, Burlingame, CA. 94010, USA
Phone: +1.650.692.8100 – Email: info@trackingtheworld.com – Website: www.trackingtheworld.com

Copyright © TrackingTheWorld. All rights reserved. Information in this publication supersedes that in all previously published material. Specification and price change privileges reserved. All trade names referenced are the service marks, trademarks, or registered trademarks of their respective companies.

3. Getting Started

3.1. Parts List

- PT-301 Locator
- 1000mAh Li-ion battery
- AC power adapter
- USB earphone



3.2. Battery Charging

- Please connect AC power adapter with PT-301 for battery charging.
- Insert the AC power adapter into the power supply.
- During charging, the battery capacity indicator in icon area will flash periodically; when charging in power-off state, charging indicator on the screen means PT-301 is charging now.
- When the capacity indicator in icon area shows the battery is full and doesn't flash any more, the charging process is complete. If your phone is charged in power off state, "Charging Complete" will be displayed on the screen.
- You can also charge the battery with a USB cable which connects PT-301 with the PC.
- Charging process usually takes about 3 hours.

Note: Before using the PT-301 for the first time, please fully charge the battery.



For More Information: Please contact TrackingTheWorld, 1633 Bayshore Highway, Suite 390, Burlingame, CA. 94010, USA
Phone: +1.650.692.8100 – Email: info@trackingtheworld.com – Website: www.trackingtheworld.com

Copyright © TrackingTheWorld. All rights reserved. Information in this publication supersedes that in all previously published material. Specification and price change privileges reserved. All trade names referenced are the service marks, trademarks, or registered trademarks of their respective companies.

3.3. Install the SIM Card

- First turn off the PT-301 and open the battery cover
- Remove battery;
- Slide the SIM card into the SIM card slot as shown below;
- Put the battery back in place and close the cover.

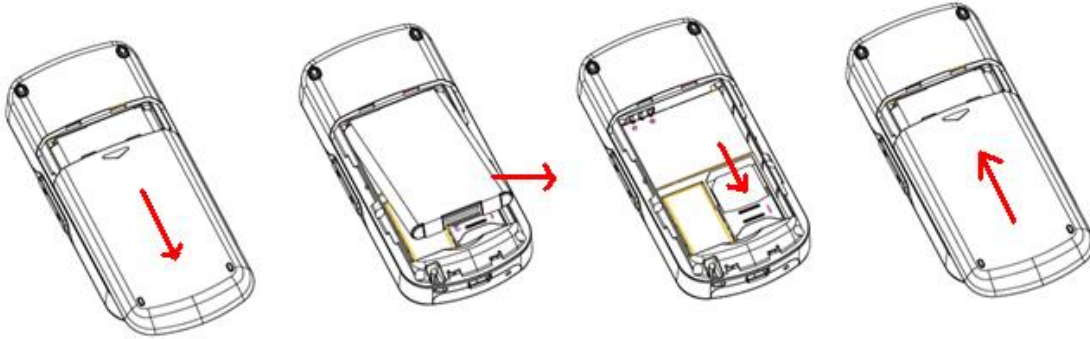

3.4. Turning PT-301 On or Off

- To turn on PT-301, please hold down the Power Key.
- PT-301 will then automatically test whether the SIM Card is inserted and valid. If you set the SIM Lock, PT-301 will ask you to input PIN to unlock the SIM card. And then PT-301 will conduct a search to find the appropriate network connections.
- In power-on state, hold down Power Key to turn off PT-301.

Unlocking the SIM card

In order to protect users against unlawful use, the SIM card uses a PIN number. If you insert a SIM card into PT-301 which has a PIN Code enabled on it, you must enter the PIN so as to unlock the SIM card before you use PT-301.

- Press Speed Dial Key 1/4 (Volume +/- Key) to scroll the screen sideways.
- Press SOS Key to enter an appropriate number; press Right Soft Key to clear mistakes.
- Finish by pressing Left Soft Key.
- If the correct Pin number has been entered, you will see a Code accepted message displayed on the screen.

Note: You will only have 3 attempts to enter the correct Pin number. After that you may have to contact your service provider to unlock your SIM.

3.5. Make a Normal Call

- Users can preset 20 controlled contacts using software and the first four numbers are for the Speed Dial number (1, 2, 3, 4)

For More Information: Please contact TrackingTheWorld, 1633 Bayshore Highway, Suite 390, Burlingame, CA. 94010, USA
Phone: +1.650.692.8100 – Email: info@trackingtheworld.com – Website: www.trackingtheworld.com

Copyright © TrackingTheWorld. All rights reserved. Information in this publication supersedes that in all previously published material. Specification and price change privileges reserved. All trade names referenced are the service marks, trademarks, or registered trademarks of their respective companies.

- When you want to make a phone call, first press **Speed Dial Key X**, and then press **Left Soft Key** to call this preset number.
- Press End key to end the call while in dialing process.
- If the call is received, it will be in talking state.
- Press **Right Soft Key** to end the call while in talking state.

3.6. Make an Emergency Call

- At first, user should pre-set one SOS number.
- When confronted with emergency situations, the user can hold down the SOS Key to dial the SOS number for help.

For More Information: Please contact TrackingTheWorld, 1633 Bayshore Highway, Suite 390, Burlingame, CA. 94010, USA
Phone: +1.650.692.8100 – Email: info@trackingtheworld.com – Website: www.trackingtheworld.com

Copyright © TrackingTheWorld. All rights reserved. Information in this publication supersedes that in all previously published material. Specification and price change privileges reserved. All trade names referenced are the service marks, trademarks, or registered trademarks of their respective companies.

4. Function Menu

4.1. Menu Tree

- 1) Call History
 - a) Missed Calls
 - b) Dialed Calls
 - c) Received Calls
 - d) Delete Call Logs
 - i) Missed Calls
 - ii) Dialed Calls
 - iii) Received Calls
 - iv) Delete All
- 2) Check GPS
- 3) Messages
 - a) Inbox
 - b) Delete Inbox
- 4) Sound
 - a) Ring Volume
 - b) Keypad Volume
- 5) Setting
 - a) Language
 - b) LCD Backlight
 - c) LCD Contrast
 - d) Auto Keypad Lock
 - e) Auto Answer Setting
 - i) Normal Auto Answer
 - ii) Silent Auto Answer
 - f) SIM Lock
- 6) Alarm
- 7) Contact
 - a) Speed Dial
 - b) Controlled Contact
 - c) SIM Contact (Optional)
- 8) SIM
- 9) Alarm Check
 - a) Support Alert
 - b) Fall Alert
 - c) Zone Alert
 - d) Battery Alert

For More Information: Please contact TrackingTheWorld, 1633 Bayshore Highway, Suite 390, Burlingame, CA. 94010, USA
Phone: +1.650.692.8100 – Email: info@trackingtheworld.com – Website: www.trackingtheworld.com

Copyright © TrackingTheWorld. All rights reserved. Information in this publication supersedes that in all previously published material. Specification and price change privileges reserved. All trade names referenced are the service marks, trademarks, or registered trademarks of their respective companies.

Note: SIM Contact menu only shows when PT-301 is set up to use SIM contacts function.

4.2. Call History

The Call History stores the last twenty missed /received /dialed calls.

Press Left Soft Key to enter the Call History menu. There are 4 items in this menu, namely, “**Missed calls**”, “**Dialed calls**”, “**Received calls**”, and “**Delete call logs**”. Press Speed Dial Key 1/4 (Volume +/- Key) to scroll these items and press Left Soft Key to enter the selected item.

- **Missed calls:** A list of missed calls.
- **Dialed calls:** A list of dialed calls.
- **Received calls:** A list of received calls.
- **Delete call logs:** When the record is not empty, you can delete record of Missed Calls, Dialed Calls and Received Calls, or select the “Delete All” option to delete all call record.

4.3. Check GPS

GPS location acquisition test can be performed by using this option located in the main menu.

Press Left Soft Key to enter the Check GPS. PT-301 will search GPS signal and fix location. When GPS positioning succeeds, the screen will display your location information (including longitude, latitude, speed etc.). Then according to the home city and daylight saving setting, PT-301 will automatically adjust system time with GPS UTC time.

Note: The time zone may be different for each different Home city you select.

4.4. Check GPS

Press Left Soft Key to enter message menu. There are two items in this menu, namely, “Inbox” and “Delete Inbox”. Press Speed Dial Key 1/4 (Volume +/- Key) to scroll these items and press Left Soft Key to enter the selected item.

- **Inbox:** When receiving a message, PT-301 will vibrate or ring to notify of a new message. If you don't read immediately, an unread message icon appears in icon area. If there is no room to store, you will see the flashing icon for the new message on the screen.
Press Left Soft Key to read the details of the message on the message list. If you want to delete this message, press Left Soft Key to delete it and confirm this by pressing Left Soft Key again.
Note: The Inbox limit is 200 SMS messages.
- **Delete Inbox:** Press Left Soft Key to delete all messages in inbox and confirm this by pressing Left Soft Key again.

4.5. Sound

In main menu, press Left Soft Key to enter Sound menu. There are 6 items in this menu:

- **Alert Mode:** Ring or Vibration
- **Ring Tone:** 25 ring tones

For More Information: Please contact TrackingTheWorld, 1633 Bayshore Highway, Suite 390, Burlingame, CA. 94010, USA
Phone: +1.650.692.8100 – Email: info@trackingtheworld.com – Website: www.trackingtheworld.com

Copyright © TrackingTheWorld. All rights reserved. Information in this publication supersedes that in all previously published material. Specification and price change privileges reserved. All trade names referenced are the service marks, trademarks, or registered trademarks of their respective companies.

- **Ring Volume:** 1---7
- **Keypad Volume:** 1---7
- **Alarm Tone:** 25 ring tones
- **Message Tone:** 10 tones or Silent

4.6. Settings

In main menu, press Left Soft Key to enter Setting menu. There are seven items in this menu:

- **Time and Date:**
 - Set Home City:** Select the home city in 77 cities.
 - Set Time/Date:** Set the current time and date of PT-301 according to established format.
 - Set Format:** Set time and date format.
- **Language:** Switch between English and Espanol.
- **LCD Backlight:** Set Backlight level.
- **LCD Contrast:** Set Contrast level.
- **Auto Keypad Lock:** Select from 5 sec, 30 sec, 1 min and 5 min. In standby mode, if you do nothing for a specific period of time, keypad will automatically lock. If you select "off", this function will be cancelled.
- **Auto Answer Setting:** Select from Normal Auto Answer, Silent Auto Answer and Handsfree Auto Answer to answer the incoming calls automatically. If you select "off", this function will be cancelled.
- **Restore Factory Settings:** The input password is 1122.

4.7. Alarm

PT-301 can set five alarms at most, and hold out the alarm when the phone is powered off. For each alarm, there are several options including Turn on/off, Time, Repeat, Snooze (mins) and Alert Mode.

4.8. Alarm

Although PT-301 has only 4 speed dial keys, it can store a total of 20 numbers in its Controlled Contact. These numbers are preset and managed from the software platform.

Press Left Soft Key to enter Contact menu. There are three items in this menu:

- **Speed Dial:** Shows the speed dial key numbers 1 - 4.
- **Controlled Contact:** Shows all controlled numbers. Use Speed Dial Key 1/4 (Volume +/- Key) to scroll through the numbers. Press Send Key to dial the selected number.
- **SIM Contact:** Shows all numbers saved in SIM card. Use Speed Dial Key 1/4 (Volume +/- Key) to scroll through the numbers. Press Send Key to dial the selected number.
 - Note: This menu only shows when PT-301 is set up to use SIM contracts function.**
- **SOS Number:** Shows the currently set SOS alert number.

For More Information: Please contact TrackingTheWorld, 1633 Bayshore Highway, Suite 390, Burlingame, CA. 94010, USA
Phone: +1.650.692.8100 – Email: info@trackingtheworld.com – Website: www.trackingtheworld.com

Copyright © TrackingTheWorld. All rights reserved. Information in this publication supersedes that in all previously published material. Specification and price change privileges reserved. All trade names referenced are the service marks, trademarks, or registered trademarks of their respective companies.

5. Troubleshooting and Safety Info

5.1. Troubleshooting

Trouble	Possible Reason	Solution
Poor reception	Using the device in an area with poor reception such as near tall buildings or in a basement where radio waves cannot be transmitted.	Try to avoid
	Using the device when the network is busy, such as during rush hour, when the lines are full making it impossible to get through.	Try to avoid
	Related to the distance from the base station built by the network.	You can request that the network service provider provide a service area plan.
Echo or noise	Caused by poor network relay, a regional problem.	Hang up and redial. If the relay is changed, then the line may be better.
	Some calling regions have poor lines.	
Shortening of the standby time	Standby time is related to the network system.	Please temporarily turn off your device, when you are located in an area with poor reception.
	Batteries need to be replaced.	Replace the batteries
	When you cannot get a signal, the phone will continue to transmit in order to find a base station, thereby consuming large amounts of electricity which will cause the standby time to decrease.	Please move to an area with a strong signal or temporarily turn off your device.
Unable to turn on the device	The battery is empty.	Look at the remaining electricity or recharge.
SIM card malfunction	SIM card is damaged.	Contact your network service provider.
	SIM card is not properly inserted.	Confirm SIM card is properly inserted.
	There is a foreign substance on the metal surface of the SIM card.	Use a clean cloth to wipe off the metal contact point of the SIM card.
Unable to connect with the network	Expired SIM card	Contact your network provider.
	Outside the GSM service area	Consult your network provider in the service area.

For More Information: Please contact TrackingTheWorld, 1633 Bayshore Highway, Suite 390, Burlingame, CA. 94010, USA
Phone: +1.650.692.8100 – Email: info@trackingtheworld.com – Website: www.trackingtheworld.com

Copyright © TrackingTheWorld. All rights reserved. Information in this publication supersedes that in all previously published material. Specification and price change privileges reserved. All trade names referenced are the service marks, trademarks, or registered trademarks of their respective companies.

	Poor signal	Please move to a place with a better signal and try again.
Incorrect PIN number	Consecutively enter the wrong password three times.	Contact your network provider.
Unable to charge	Battery or charger is damaged.	Replace the battery or charger.
	Recharging in an environment of lower than -10°C or higher than 45°C.	Change the charging environment.
	Poor contact	Check if the plug is properly connected.

5.2. Safety Info

- Please do not immerse the device in liquids.
- Please do not store the device in wet, dirty or dusty environments.
- Please do not expose the device to extreme temperatures.
- Please do not place the phone in or near microwave emitting devices.
- Please do not operate or store the device near flammable materials.
- Please do not use the device in restricted areas without permission.
- Avoid dropping, throwing or putting heavy pressure on the device.
- Please do not attempt to, or actually open, or alter the device or any of its accessories from its casing in any way.
- Only use authorized approved accessories with the device.

For More Information: Please contact TrackingTheWorld, 1633 Bayshore Highway, Suite 390, Burlingame, CA. 94010, USA
Phone: +1.650.692.8100 – Email: info@trackingtheworld.com – Website: www.trackingtheworld.com

Copyright © TrackingTheWorld. All rights reserved. Information in this publication supersedes that in all previously published material. Specification and price change privileges reserved. All trade names referenced are the service marks, trademarks, or registered trademarks of their respective companies.